



JR CLANCY
SC5500 Console User Guide

The logo features the letters 'JR' in a bold, green, sans-serif font. The 'J' and 'R' are connected at the bottom. To the right of 'JR', the word 'CLANCY' is written in a bold, black, sans-serif font. Below the logo, the text 'SC5500 Console User Guide' is displayed in a bold, black, sans-serif font.

SC5500 Console User Guide

P/N: 5013-00

Version 1.00

June 2014

Copyright © 2001–2014 by J.R. CLANCY INC.

J.R. CLANCY INC.

7041 Interstate Island Road
Syracuse NY 13209

Domestic Toll Free: 800 836 1885
International: 001 315 451 3440
24 Hour: 315 451 3440
Fax: 315 451 1766

General Inquiries

info@jrclancy.com

Software/Controls Inquiries

automation@jrclancy.com

Questions/comments regarding this document should be addressed to J.R. CLANCY INC.

This document contains proprietary and confidential information of J.R. CLANCY INC. and is protected by copyright law. The contents of this document may not be disclosed to third parties, translated, copied, or duplicated in any form, in whole or in part, without the express written permission of J.R. CLANCY INC.

J.R. CLANCY INC. reserves the right to change the information contained in this document without notice.

All product names shown are trademarks or registered trademarks of their respective owners.

For latest revision notes and updates check the Readme.txt file contained on your **RAYNOK** CD.

SC5500 Console User Guide

The **J.R. Clancy SC5500 Console** is the hardware interface to the **RAYNOK SOFTWARE**. The operator can, with minimal use of the touch screen, mouse, and/or keyboard, send commands to the software to execute *GO*, *STOP*, *Manual* and all other executable commands from the user programmable macro buttons.

The **J.R. Clancy SC5500 Console** also has the Operator's *E-stop*, *E-stop Reset*, *E-stop Reset Lockout* controls and a manual control joystick. The **SC5500** macro buttons interface is all done right on the main touch screen via the **RAYNOK RJC 5000** Interface. The **SC5500** computers and monitor power is supplied from the **SceneControl® Power Distribution**, described later in the manual.

Review the following diagrams on the next few pages and familiarize yourself with the **J.R. Clancy SC5500 Console** buttons, input/output ports, and features.



SC5500 Console List of Parts

Review the diagrams below to familiarize yourself with the **SC5500 Console** operator buttons and physical features.

SC5500 Console ISOMETRIC View Layout

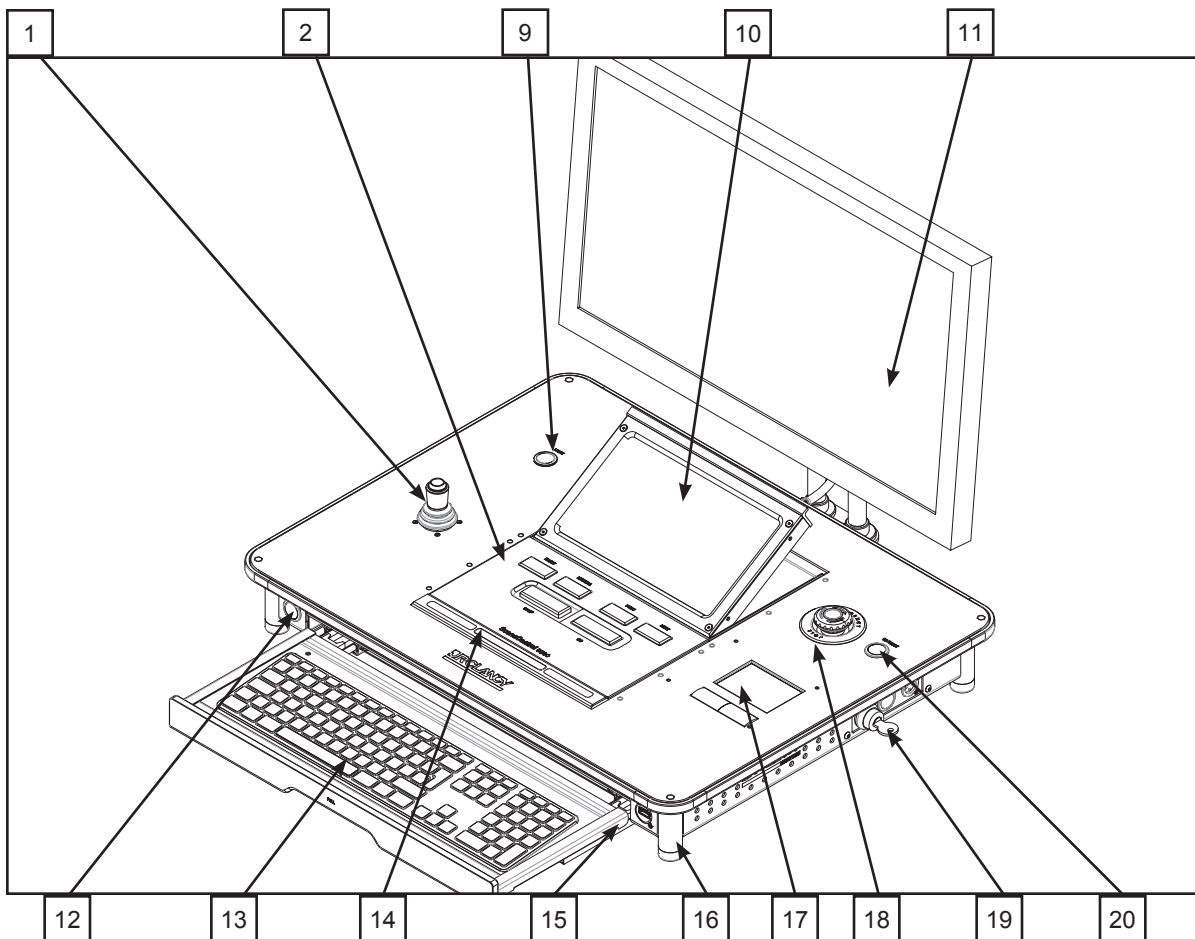

SC5500 Console Helm View Layout

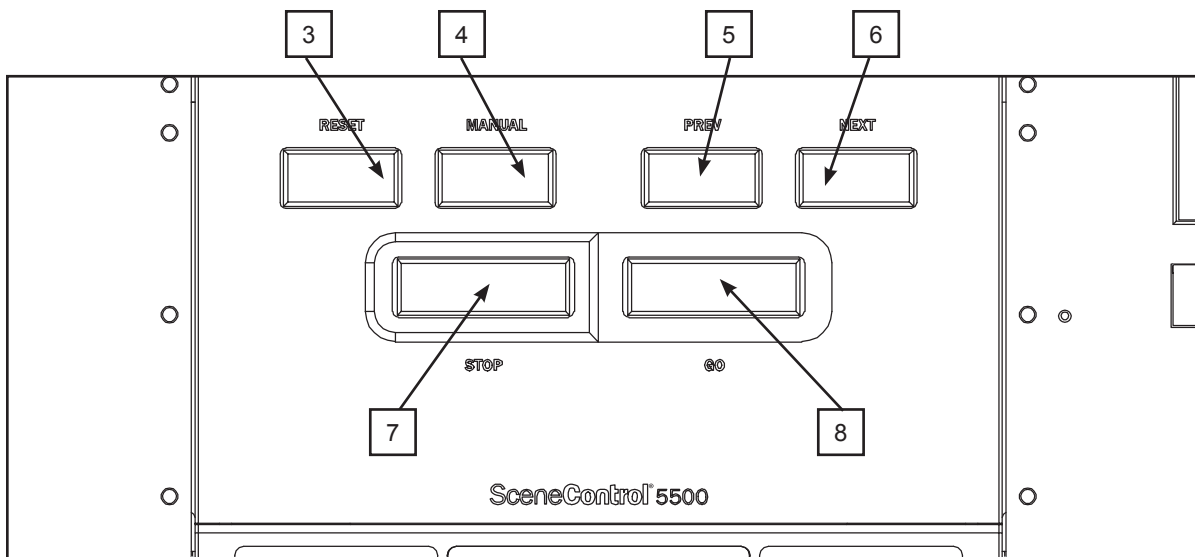

- 1 – Joystick
 - Use the joystick to manually jog axes. Press the button on the top of a joystick to enable the jog function on selected axes.
- 2 - Console Helm
 - The main tactile buttons of the **SC5500 Console** are found here. Refer to the next several lines for detailed information on the buttons.
- 3 - Reset Axis
 - Press this button to reset the axis that is currently selected in the **RAYNOK SOFTWARE**
- 4 – Manual Cue
 - Used to toggle the **RAYNOK SOFTWARE** from the pre-programmed show cues to the Manual Cue Mode so that the operator can set up a temporary cue.
- 5 – Previous Cue
 - Used to return the **RAYNOK SOFTWARE** to select the previous show cue for execution.
- 6 – Next Cue
 - Used to advance the **RAYNOK SOFTWARE** to select the next show cue for execution.
- 7 – Stop
 - Used to send the STOP command through the **RAYNOK SOFTWARE**
 - the STOP button is illuminated RED.
- 8 – GO
 - Used to send the GO command through the **RAYNOK SOFTWARE**
 - The GO button is illuminated GREEN.
- 9 - Light Dimming Switch
 - This switch adjusts the dimming of the LittlLite that is currently connected to either of the XLR ports on the Left and Right side of the Console. Functions for dimming are as follows:
 - Hold the button down to dim the light slowly between the ON and OFF positions.
 - Press the button to toggle the light between ON and OFF.
- 10 - Console Screen
 - The main visual display for the **RAYNOK RJC 5000** Interface. See the **RAYNOK RJC 5000 INTERFACE GUIDE** for further instructions on running the Console Screen in conjunction with **RAYNOK**.
- 11 - Main Monitor
 - This 24" 1920x1080 LCD Monitor is the main visual display for the **RAYNOK SOFTWARE**
- 12 - Main PC ON/OFF
 - Turns the PCs inside the console ON or OFF. Hold the button down for 4 seconds to turn the computers off, and hold it for 1 second to reset
- 13 - Keyboard

The main keyboard of the computer inside the console. Use this as you would any regular PC keyboard. It is recommended to push the keyboard tray in until it locks in when running the Console in Show Mode.
- 14 – Hold to Run
 - The HTR operator enables and inhibits all axes from motion. Press the HTR to enable all axes; release the HTR to inhibit all axes. The lights will illuminate BLUE when it is held down for the amount of time determined by the **RAYNOK SOFTWARE**. The lights will be RED when the system is in E-STOP and ORANGE when the system is in a standby state.
- 15 – USB Port
 - Plug any USB device into this, such as a memory card stick, external hard drive, or a mouse
- 16 - LED Legs
 - The legs will illuminate depending on the state of the system. See (14) for further description of the various system states.
- 17 - Mouse Pad and Buttons
 - Use this mouse pad as you would a laptop mousepad.
- 18 – Emergency Stop Button
 - Used to Stop the entire system in the case of an emergency.
- 19 – E-Stop Reset Lockout
 - Locks out the local E-stop Reset button so that the resetting of the Emergency Stop System can be properly managed. turns Off and On the E-stop System and resets the system in conjunction with the reset button.
- 20 – E-Stop Reset
 - Used to reset the Emergency Stop System in conjunction with the E-Stop Reset Lockout Switch.

SC5500 Console Rear View Layout

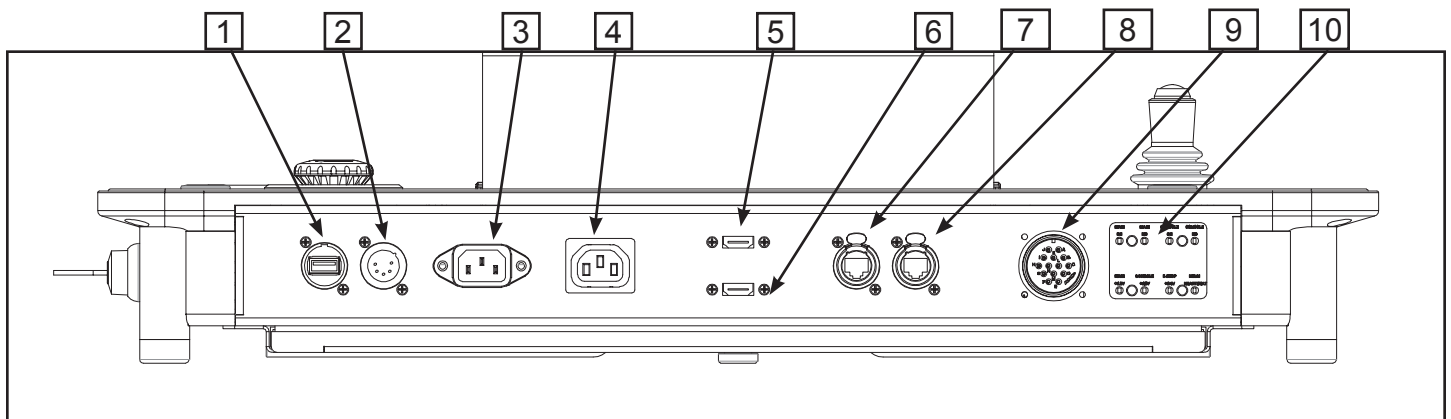

- 1 - Touch Screen USB Port
 - Attach any USB-based device to this port. May or may not be available depending on venue.
- 2 – MAIN PC Power Inlet
 - Plug the cable labeled ‘Main PC Power’ into this socket from the Console Power Distribution.
- 3 - MONITOR POWER INLET
 - Used to supply power to the monitor. This is connected from the SceneControl PD.
- 4 - MONITOR POWER OUTLET
 - Used to supply power to the monitor.
- 5 – HDMI port 1
 - Connect the Monitor to this port
- 6 - HDMI Port 2
 - Touch Screen Monitor external output. Only necessary for testing the Touch Screen.
- 7 – NET A FIELD MAIN 10 Base-T port
 - Connects the **SC5500 Console** to the Network Uplink.
- 8 - NET B FIELD MAIN 10 Base-T port
 - Do not connect this unless diagnosing the Rabbit Microprocessor.
- 9 – Emergency Stop I/O
 - Connects the *Emergency Stop*, *E-stop Reset Lockout key* and the *E-stop Reset buttons* to the main Emergency Stop System.
- 10 – Rear LED Indicators
 - Show various states of the PC and the control system as described in the next paragraphs.

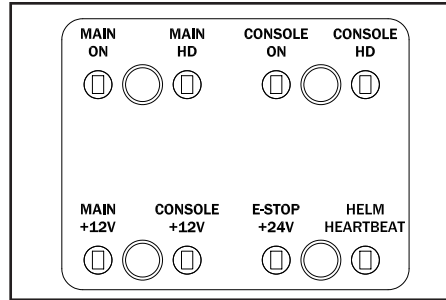

REAR LEDs DETAIL

- 1 – MAIN ON
- Main PC is turned on.
- 2 - MAIN HD
- Main PC hard drive is being accessed
- 3 – CONSOLE ON
- Console PC (Touch Screen PC) is turned on.
- 4 - CONSOLE HD
- Console PC (Touch Screen PC) hard drive is being accessed
- 5 - MAIN +12V
- Indicates that there is 12 Volts running to the Main PC
- 6 - CONSOLE +12V
- Indicates that there is 12 Volts running to the Console PC and Hubs
- 7 - E-STOP +24V
- The E-Stop System is connected and bringing 24V to the E-STOP Reset, E-STOP BUTTON, and Keyswitch
- 8 - HELM Heartbeat
- Indicates that the HELM PCB is functioning by flashing ON and OFF every 1 second.

SC5500 Console Left View Layout

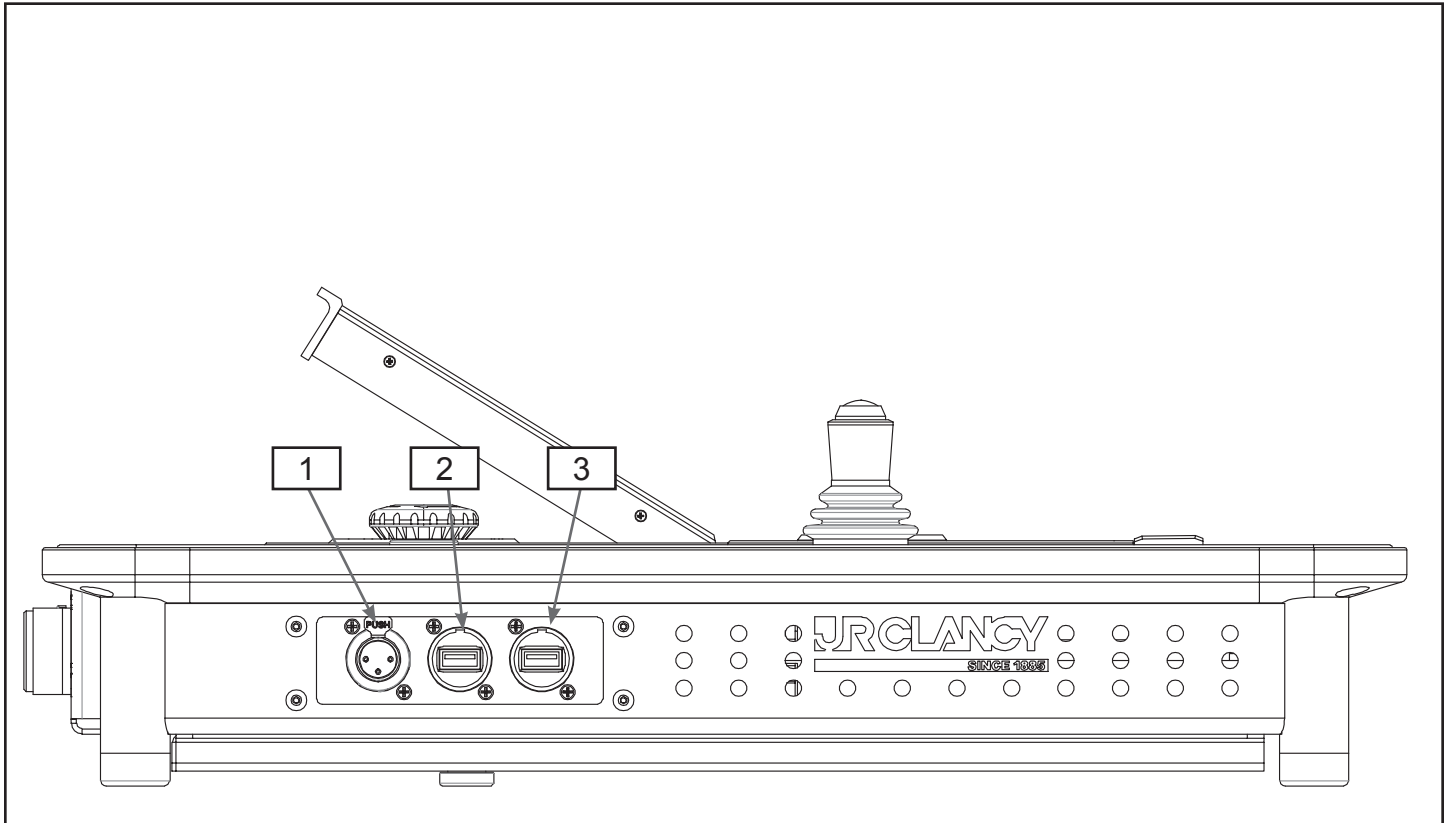

- 1 – Light Power 3-PIN XLR
 - LittleLite +12VDC power source outlet

- 2 – USB Port
 - Plug any USB device into this, such as a memory card stick, external hard drive, or a mouse

- 3 – USB Port
 - Plug any USB device into this, such as a memory card stick, external hard drive, or a mouse

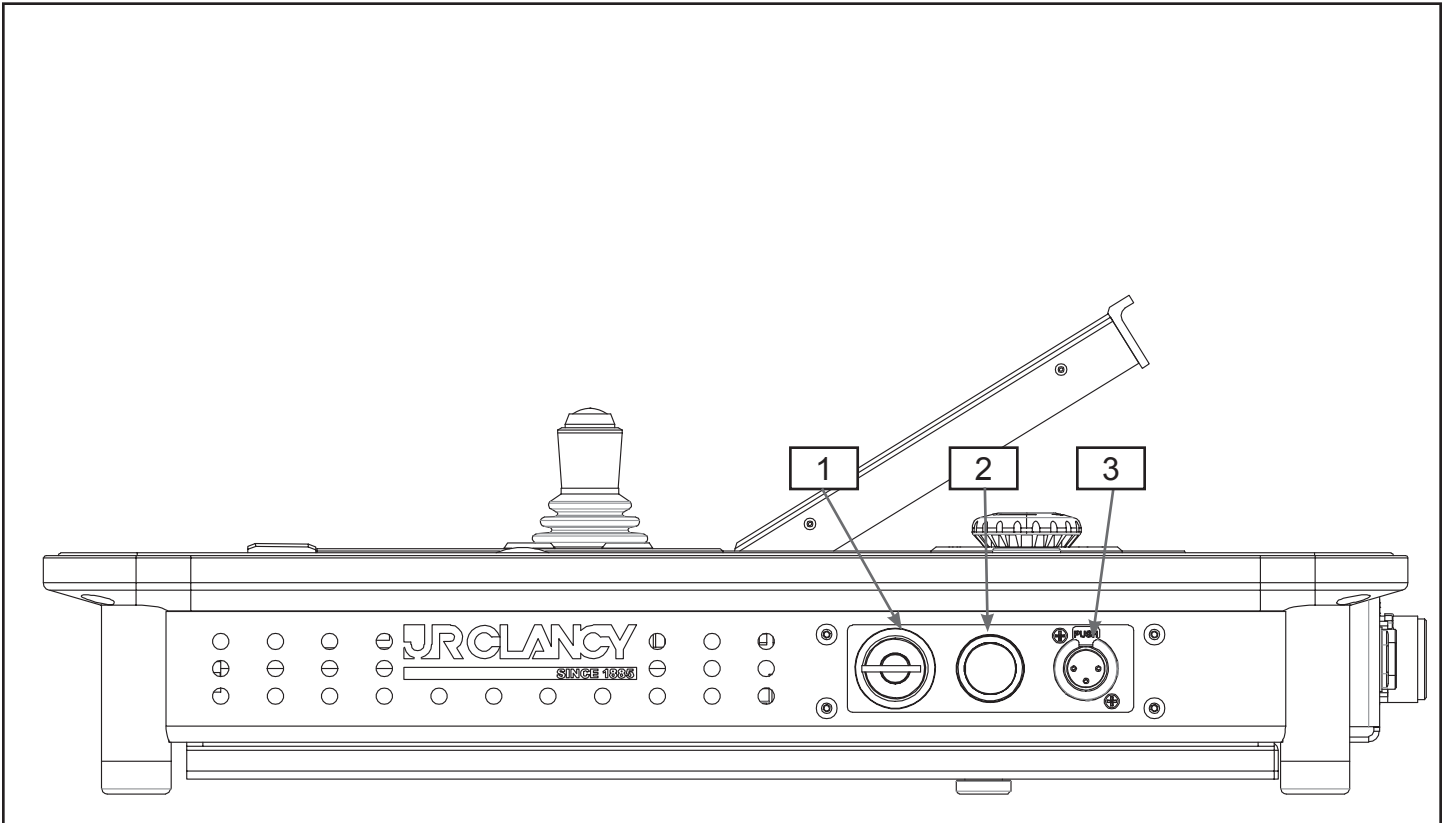
SC5000 Console Right View Layout**1 – E-Stop Reset Lockout**

- Locks out the local E-stop Reset button so that the resetting of the Emergency Stop System can be properly managed. turns Off and On the E-stop System and resets the system in conjunction with the reset button.

2 – Console Power Switch

- Turns the **SC5500 Console** HELM on and off. The switch will stay depressed (latched).

3 – Light Power 3-PIN XLR

- LittleLite +12VDC power source outlet

NOTE:

The **SC5500 Console** can be turned OFF and the E-Stop system will still function properly.

SceneControl® Power Distribution

The **SceneControl Power Distribution** is the main source of power for the **SC5500 Console**. Familiarize yourself with the diagram below and follow safe operating procedures when connecting any cables to their inlets/outlets. Note: The diagram below may not be an exact representation of the PD, but all the items are identical and functionality remains the same.

Front View

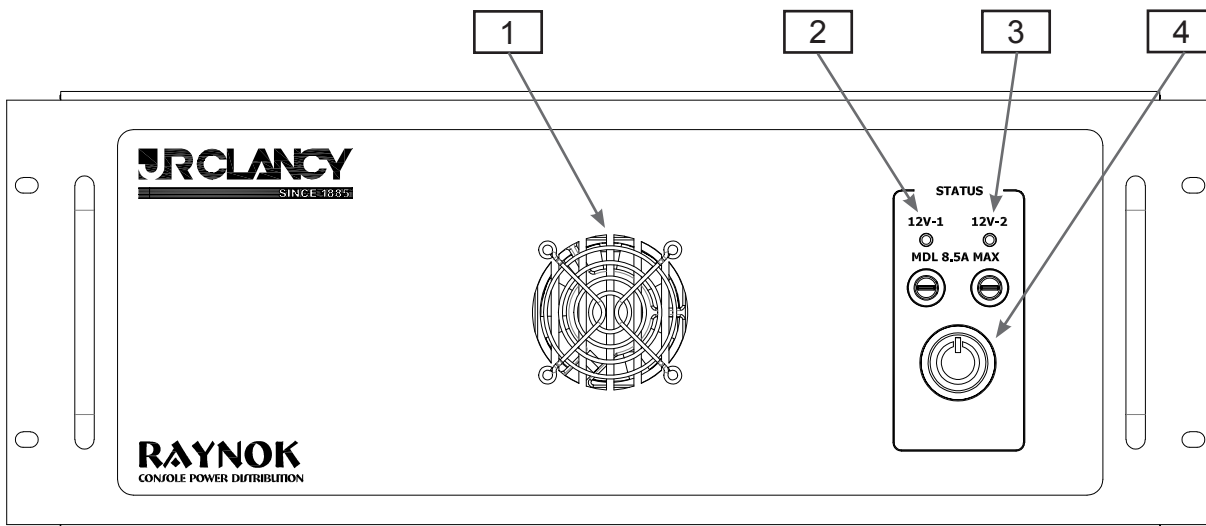

Rear View

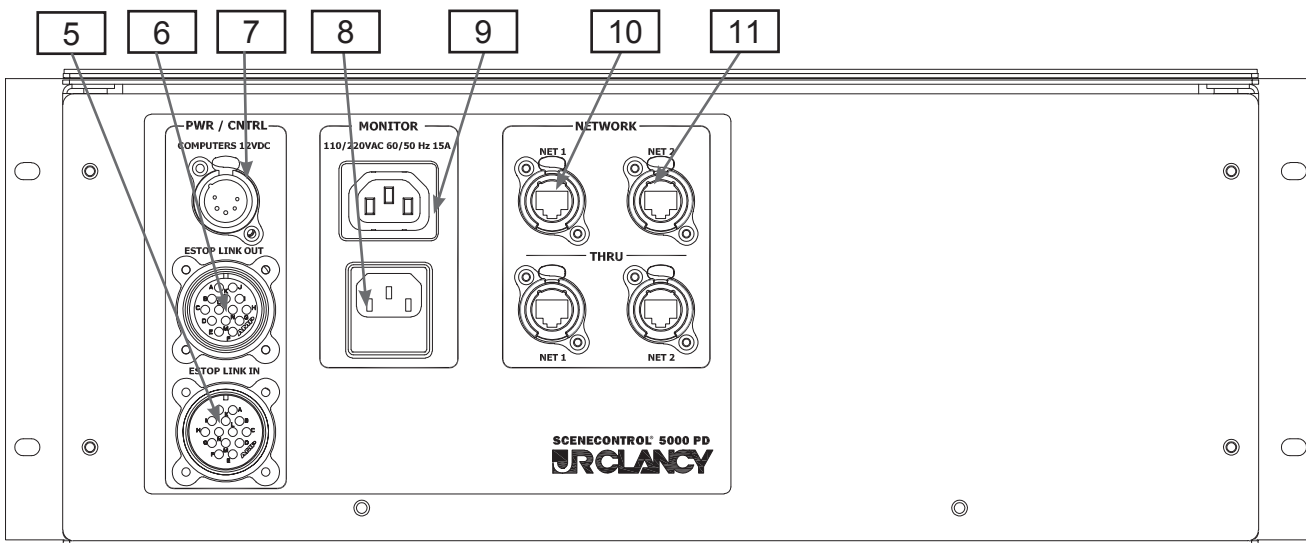

- 1 - FAN VENTILATION
 - Ensure this vent is not blocked, as the Power Supplies in the unit need sufficient ventilation in order to not overheat
- 2 - MAIN 12VDC INDICATOR / FUSE
 - Main PC power fuse and power indicator
- 3 - SECONDARY 12VDC INDICATOR / FUSE
 - Touch Screen PC and NET HUB power fuse and power indicator
- 4 - Power Button
 - Push this button to turn the power on for the 12V Power Supplies. The button will be lit when the power is on
- 5 - E-STOP LINK IN PORT
 - connect the main emergency stop system through this port
- 6 - E-STOP LINK OUT PORT
 - Used to connect the SceneControl Console to the Emergency Stop System. Connect this port to the rear of the SceneControl Unit.
- 7 - MAIN PC POWER OUTLET
 - Used to supply power to the main PC(s) and devices within the Console.
- 8 - POWER INLET
 - Connect the Back-UPS unit to this port to provide the unit with AC Power.
- 9 - MONITOR POWER OUTLET
 - Used to supply power to the monitors.
- 10 - NET-1
 - Network 1 pass through ports
- 11 - NET-2
 - Network 2 pass through ports

Connecting the **SC5500 Console** To the Main System

1. **BEFORE USING YOUR **SC5500 Console** BE SURE YOU UNDERSTAND AND FOLLOW ALL BASIC SAFETY GUIDELINES AS LAID OUT BY YOUR SYSTEM ADMINISTRATOR.**
2. Ensure that the E-stop button on the **SC5500 Console** is pushed in.
3. Press and pull out the local E-stop button on the E-Stop Master Controller to disable the system.
4. Connect the Console Power Distribution (PD) to the CONSOLE-1 Port on the E-Stop Master Controller using the E-Stop/Data Extension Cable.
5. Pull out the *Emergency Stop* button on the **SC5500 Console**.
6. Turn and hold the *Emergency Stop Reset Lockout* key and press the *E-stop Reset* button.
7. Release the *Emergency Stop Reset Lockout* key and *E-stop Reset* button.
8. The Main Emergency Stop System should now be reset.
9. Press the *Emergency Stop* button.
10. The Emergency Stop System should now be disabled.
11. Turn on the power switch for the **SC5500 Console Helm** using the switch on the right hand side of the console.
12. Your **SC5500 Console** will now perform a self-diagnostic test, lamp test and boot up.
13. You are now ready to confirm communications and use your **SC5500 Console**.
14. Once you have confirmed communications, reset the Main Emergency Stop System by following items 5, 6 and 7 above.

IMPORTANT NOTE OF CAUTION!!!

Before you operate any equipment connected to your system it is imperative that you test your Emergency Stop and E-stop Reset buttons. Failure to do so could result in a serious injury or even death should this equipment not be ready to function when needed.

Console Startup & Shutdown Procedure

Startup

Press the Power Button for the Main Computer

Wait for computer to boot up

Start **RAYNOK** and Login

Open the Show File needed for the venue.

Setup Menu - "GO ONLINE"

Reset E-Stop System - Turn the key switch to the right, hold and press "RESET".

Setup menu - "EXIT E-STOP RESET MODE" (If Applicable)

Turn Console "ON" - Power Switch on Right

Shutdown

E-Stop system - Push in and pull out E-Stop Button

Setup menu - "GO OFFLINE"

"YES" to save current positions

File Menu - "EXIT"

Save Changes - "YES"

Computer Start menu - "SHUT DOWN" (wait until computer totally shuts down)

RAYNOK Basic Procedures

To Move Battens

Reset E-Stop system

Setup Menu - "EXIT E-STOP RESET MODE"

Select batten

Set target by using any of the following

1. Use "INTRIM" macro
2. Use "OUTTRIM" macro
3. Or use "ASK TARGETS" macro

Reset Axis

Press "GO" to initiate movement

Press "STOP" to stop if needed

Press "CLEAR" to deselect all battens

Press "MANUAL CUE" twice to clear targets

Select another batten

And so on....

To Jog Battens

Select batten.

Reset Axis

Press down the button on top of the joystick to start the machine, and move the joystick in desired direction and to jog the batten

Test and Boot Up of the SC5500 Console

After turning on the power to the **SC5500 Console** it will perform a lamp test to illustrate to you that all of the LED indicators are in proper working order. The LEDs will turn on and then off, chase from left to right, top to bottom and then turn on and off again.

Once this lamp test is complete the **SC5500 Console** will complete its boot up process and self test and be ready for use. For details on how to confirm that the unit is communicating with the rest of the network properly refer to your **RAYNOK SOFTWARE GUIDE**.

SC5500 Console Manual Control Joystick

The Manual Control Joystick is available for the operator to use to control individual or non-linked axis or axis groups for simple jog moves.

Basic Operation

1. **BEFORE USING YOUR SC5500 CONSOLE LOCAL MANUAL CONTROL JOYSTICK, BE SURE YOU UNDERSTAND AND FOLLOW ALL BASIC SAFETY GUIDELINES AS LAID OUT BY YOUR SYSTEM ADMINISTRATOR.**
2. Select an axis by highlighting it on your monitor with your mouse. Refer to your **RAYNOK SOFTWARE GUIDE** for details on how to do this properly.
3. Allow the joystick to sit in its centre “off” position without the aid of your hand.
4. Press and hold the Joystick Enable button on the top of the joystick.
5. Wait approximately 2 seconds for the drive to produce torque and engage the brake relays.
6. You should see the status of the selected axis change to *Jogging*. Refer to your **RAYNOK SOFTWARE GUIDE** for details on the *Status Column* display
7. While looking at the machine, scenery or load in motion, gently ease the joystick in the direction of intended travel.
8. Ease up on the joystick as you approach the intended stopping point.
9. For a quick stop, release the Drive Enable button. (CAUTION: BE certain that a quick stop will NOT damage attached equipment BEFORE attempting to release the Drive Enable while in motion)

NOTES

NOTES