

Traditional Acoustic Panel Series: Absorber Panels



Absorber Panels

Panel fabric covering utilizes the Guilford of Maine company, model FR701, style 2100, and is available in a variety of colors. We can accommodate non-standard styles and colors pending manufacturing approval. Contact Wenger for additional information.

- Manufacturer's standard construction of 2" (51 mm), 3" (76 mm), and 4" (102 mm) thick 6 pcf, glass fiber board, hardened resin edges, covered with Class A fabric according to NFPA 101 Life Safety Code Requirements
- Corner brackets to receive mounting hardware
- Environmental attributes and LEED compliance for this product can be found at www.wengercorp.com/GREEN or by contacting your Wenger representative
- Five-year warranty

Wall Absorber Panels

| Nominal Dimensions | Actual Dimensions | 2" (51 mm) Thick Weight | 3" (76 mm) Thick Weight | 4" (102 mm) Thick Weight |
|-----------------------------|---------------------------------------|-------------------------|-------------------------|--------------------------|
| 2' x 2' (610 x 610 mm) | 23-3/16" x 23-3/16" (589 x 589 mm) | 5 lb (2.27 kg) | 7 lb (3.18 kg) | 9 lb (4.08 kg) |
| 2' x 3' (610 x 914 mm) | 23-3/16" x 35-3/16" (589 x 894 mm) | 7 lb (3.18 kg) | 10.5 lb (4.76 kg) | 13.5 lb (6.12 kg) |
| 2' x 4' (610 x 1219 mm) | 23-3/16" x 46-7/8" (589 x 1191 mm) | 9.5 lb (4.31 kg) | 14 lb (6.35 kg) | 18 lb (8.16 kg) |
| 2' x 5' (610 x 1524 mm) | 23-3/16" x 58-7/8" (589 x 1495 mm) | 12 lb (5.44 kg) | 17.5 lb (7.94 kg) | 22.5 lb (10.21 kg) |
| 2' x 6' (610 x 1829 mm) | 23-3/16" x 70-7/8" (589 x 1800 mm) | 14.5 lb (6.58 kg) | 21 lb (9.53 kg) | 27 lb (12.25 kg) |
| 2' x 8' (610 x 2438 mm) | 23-3/16" x 94-7/8" (589 x 2410 mm) | 19 lb (8.62 kg) | 28 lb (12.70 kg) | 36 lb (16.33 kg) |
| 3' x 3' (914 x 914 mm) | 35-3/16" x 35-3/16" (894 x 894 mm) | 11 lb (4.99 kg) | 16 lb (7.26 kg) | 20.5 lb (9.30 kg) |
| 3' x 4' (914 x 1219 mm) | 35-3/16" x 46-7/8" (894 x 1191 mm) | 14.5 lb (6.58 kg) | 21 lb (9.53 kg) | 27 lb (12.25 kg) |
| 3' x 5' (914 x 1524 mm) | 35-3/16" x 58-7/8" (894 x 1495 mm) | 18 lb (8.16 kg) | 26 lb (11.79 kg) | 34 lb (15.42 kg) |
| 3' x 6' (914 x 1829 mm) | 35-3/16" x 70-7/8" (894 x 1800 mm) | 22 lb (9.98 kg) | 31.5 lb (14.29 kg) | 41 lb (18.60 kg) |
| 3' x 8' (914 x 2438 mm) | 35-3/16" x 94-7/8" (894 x 2410 mm) | 29 lb (13.15 kg) | 42 lb (19.05 kg) | 54.5 lb (24.72 kg) |
| 4' x 4' (1219 x 1219 mm) | 46-7/8" x 46-7/8" (1191 x 1191 mm) | 19 lb (8.62 kg) | 28 lb (12.70 kg) | 36 lb (16.33 kg) |
| 4' x 5' (1219 x 1524 mm) | 46-7/8" x 58-7/8" (1191 x 1495 mm) | 24 lb (10.89 kg) | 35 lb (15.88 kg) | 45 lb (20.41 kg) |
| 4' x 6' (1219 x 1829 mm) | 46-7/8" x 70-7/8" (1191 x 1800 mm) | 29 lb (13.15 kg) | 42 lb (19.05 kg) | 54.5 lb (24.72 kg) |
| 4' x 8' (1219 x 2438 mm) | 46-7/8" x 94-7/8" (1191 x 2410 mm) | 38.5 lb (17.46 kg) | 56 lb (25.40 kg) | 72.5 lb (32.89 kg) |

Note: Custom sizes are available.

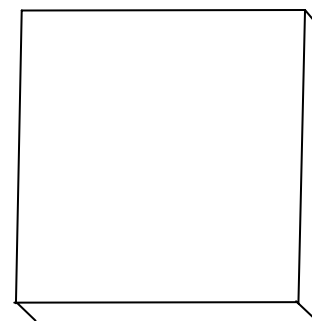

Absorber Panel

Ceiling Absorber Panels

| Nominal Dimensions | Actual Dimensions | 2" (51 mm) Thick Weight | 3" (76 mm) Thick Weight | 4" (102 mm) Thick Weight |
|-----------------------------|---------------------------------------|-------------------------|-------------------------|--------------------------|
| 2' x 2' (610 x 610 mm) | 23-3/16" x 23-3/16" (589 x 589 mm) | 5 lb (2.27 kg) | 7 lb (3.18 kg) | 9 lb (4.08 kg) |
| 2' x 3' (610 x 914 mm) | 23-3/16" x 35-3/16" (589 x 894 mm) | 7 lb (3.18 kg) | 10.5 lb (4.76 kg) | 13.5 lb (6.12 kg) |
| 2' x 4' (610 x 1219 mm) | 23-3/16" x 46-7/8" (589 x 1191 mm) | 9.5 lb (4.31 kg) | 14 lb (6.35 kg) | 18 lb (8.16 kg) |
| 3' x 3' (914 x 914 mm) | 35-3/16" x 35-3/16" (894 x 894 mm) | 11 lb (4.99 kg) | 16 lb (7.26 kg) | 20.5 lb (9.30 kg) |
| 3' x 4' (914 x 1219 mm) | 35-3/16" x 46-7/8" (894 x 1191 mm) | 14.5 lb (6.58 kg) | 21 lb (9.53 kg) | 27 lb (12.25 kg) |
| 4' x 4' (1219 x 1219 mm) | 46-7/8" x 46-7/8" (1191 x 1191 mm) | 19 lb (8.62 kg) | 28 lb (12.70 kg) | 36 lb (16.33 kg) |

Note: Ceiling absorber panels mount directly to a permanent ceiling or suspend from wires only. No lay-in or clip-in option is available for suspended ceiling grids.

Installation

Acoustical Wall Panels are designed for easy installation
 Panels are shipped fully assembled with mounting brackets included for a secure installation
 Brackets are fastened (fasteners not included) to virtually any wall surface (Fig. 1)
 and the panels mount easily onto the wall brackets (Fig. 2)

Wall Absorber Installation

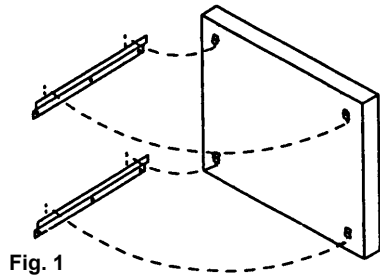

Fig. 1

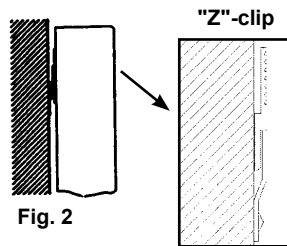
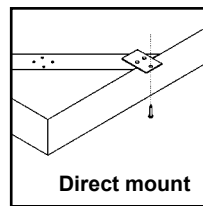
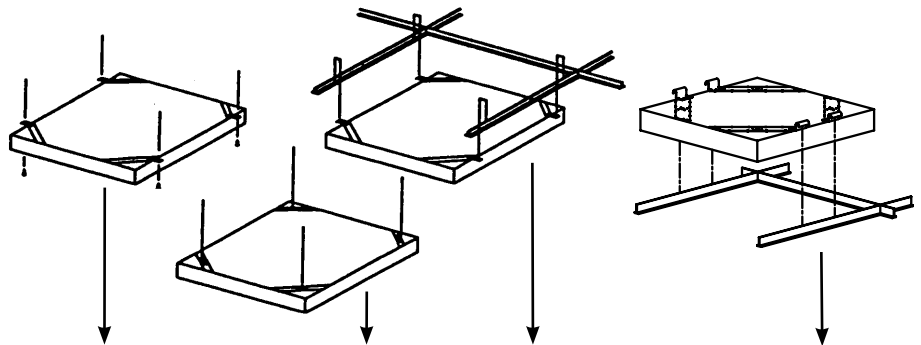
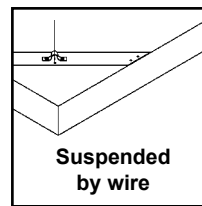

Fig. 2

Ceiling Absorber Installation



Direct mount



Suspended by wire

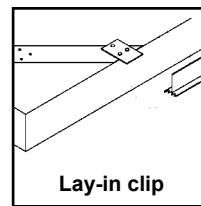

Lay-in clip

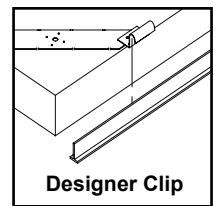

Designer Clip

Acoustical Performance - 4' (1219 mm) Panels only

| Sound Absorption Coefficient | | | | | | | |
|---|-------------|------|------|------|------|------|------|
| One-Third Octave Band Center Frequency (Hz) | | | | | | | |
| Mounting Type | | 125 | 250 | 500 | 1000 | 2000 | 4000 |
| Wall and Ceiling Absorbers 4' x 4' (1219 x 1219 mm) | | | | | | | |
| F-6 | 2" (51 mm) | 0.50 | 0.96 | 1.27 | 1.27 | 1.23 | 1.18 |
| | 3" (76 mm) | 0.65 | 1.10 | 1.31 | 1.23 | 1.20 | 1.09 |
| | 4" (102 mm) | 0.84 | 1.17 | 1.34 | 1.32 | 1.25 | 1.20 |
| F-6 Mounting 1/4" (6 mm) air space (to simulate typical wall installation). | | | | | | | |



© 2019 Wenger Corporation
 USA/2019-06/W



WENGER CORPORATION Phone 800.4WENGER (493-6437) Worldwide +1.507.455.4100 | Parts & Service 800.887.7145 | Canada Office 800.268.0148 | wengercorp.com

JR CLANCY Phone 800.836.1885 Worldwide +1.315.451.3440 | jrclancy.com | 7041 Interstate Island Road | Syracuse NY 13209-9713

GEARBOSS Phone 800.493.6437 | email gearboss@wengercorp.com | gearboss.com | 555 Park Drive, PO Box 448 | Owatonna MN 55060-0448