

# Traditional Acoustic Panel Series: Diffuser Panels



## Diffuser Panels

Diffuser panels include ceiling and wall panels. Only wall panels are fabric covered. Type I and Type II wall panels are convex shaped. Ceiling panels are either convex or pyramidal shaped. Panel fabric covering utilizes the Guiford of Maine Company, model FR701, Style 2100, Series of fabric, and is available in a variety of colors. We can accommodate non-standard styles and colors pending manufacturing approval. Contact Wenger for additional information.

- Corners are reinforced with diagonal supports, which also provide a secure anchor for the mounting hardware
- Constructed of Class A material according to NFPA 101 safety code requirements
- Five-year warranty

### Wall Diffusers Panels, Type I (Convex)

- Constructed thermo molded plastic, 0.125" (3 mm) material thickness, recyclable.

Nominal Dimensions	Actual Dimensions	Weight
2' x 2' x 5" (610 x 610 x 127 mm)	22-3/4" x 22-3/4" x 4-3/4" (578 x 578 x 121 mm)	6 lb (2.72 kg)
3' x 3' x 6" (914 x 914 x 152 mm)	35-1/4" x 35-1/4" x 5-3/4" (895 x 895 x 146 mm)	13.5 lb (6.12 kg)
3' x 4' x 6" (914 x 1219 x 152 mm)	35-1/4" x 47" x 5-3/4" (895 x 1194 x 146 mm)	18 lb (8.16 kg)
3' x 6' x 6" (914 x 1829 x 152 mm)	35-1/4" x 71" x 5-3/4" (895 x 1803 x 146 mm)	27 lb (12.25 kg)
4' x 2' x 5" (1219 x 610 x 127 mm)	47" x 23-1/2" x 4-7/8" (1193 x 60 x 124 mm)	12 lb (5.44 kg)
4' x 3' x 6" (1219 x 914 x 152 mm)	47" x 35-1/4" x 5-3/4" (1193 x 895 x 146 mm)	18 lb (8.16 kg)
4' x 4' x 7" (1219 x 1219 x 178 mm)	47" x 47" x 6.81" (1193 x 1193 x 173 mm)	24 lb (10.89 kg)
4' x 6' x 8" (1219 x 1829 x 203 mm)	47" x 71" x 7-3/8" (1193 x 1803 x 187 mm)	36 lb (16.33 kg)
4' x 8' x 8" (1219 x 2438 x 203 mm)	47" x 95" x 7-3/8" (1193 x 2413 x 187 mm)	48 lb (21.77 kg)

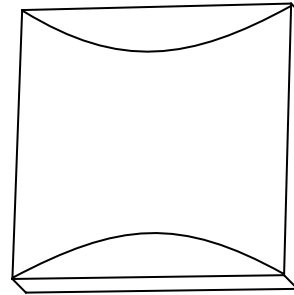

Type I Wall Diffuser

### Wall Diffusers Panel, Type II (Convex)

- Constructed of thermo molded plastic, 0.125" (3 mm) material thickness with glass fiber board glued to rear surface of panel
- Recyclable

Nominal Dimensions	Actual Dimensions	Weight
3' x 6' x 6" (914 x 1829 x 152 mm)	35-1/4" x 71" x 5-3/4" (895 x 1803 x 146 mm)	36 lb (16.33 kg)
4' x 6' x 8" (1219 x 1829 x 203 mm)	47" x 71" x 7-3/8" (1194 x 1803 x 187 mm)	48 lb (21.77 kg)
4' x 8' x 8" (1219 x 2438 x 203 mm)	47" x 95" x 7-3/8" (1194 x 2413 x 187 mm)	64 lb (29.03 kg)

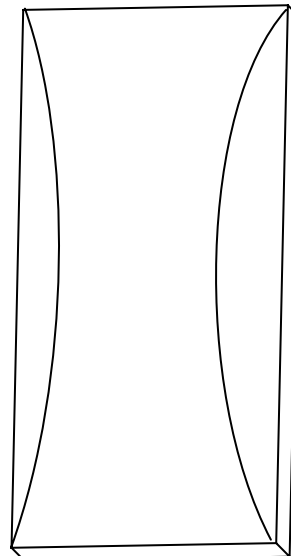

Type II Wall Diffuser

## Convex Ceiling Diffuser Panels

Nominal Dimensions	Actual Dimensions	Weight
<b>Lay-in Panel (for designer or standard grid)</b>		
2' x 2' x 6" (610 x 610 x 152 mm)	23-5/8" x 23-5/8" x 5-1/4" (600 x 600 x 133 mm)	3 lb (1.36 kg)
4' x 2' x 6" (1219 x 610 x 152 mm)	47-5/8" x 23-5/8" x 5-1/4" (1210 x 600 x 133 mm)	8 lb (3.63 kg)
4' x 4' x 8" (1219 x 1219 x 203 mm)	47-5/8" x 47-5/8" x 7-1/4" (1210 x 1210 x 184 mm)	15 lb (6.80 kg)
<b>Clip-in Panel (for direct mount or wire suspended)</b>		
2' x 2' x 5" (610 x 610 x 127 mm)	22-5/8" x 22-5/8" x 4-3/4" (575 x 575 x 121 mm)	3 lb (1.36 kg)
4' x 2' x 5" (1219 x 610 x 127 mm)	46-7/8" x 23-1/8" x 4-3/4" (1191 x 587 x 121 mm)	8 lb (3.63 kg)
4' x 4' x 7" (1219 x 1219 x 178 mm)	46-3/4" x 46-3/4" x 6.81" (1187 x 1187 x 173 mm)	15 lb (6.80 kg)

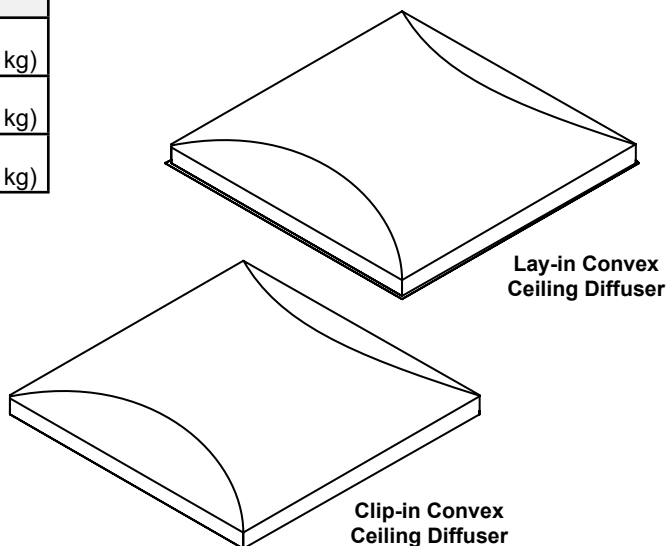

### Ceiling Diffuser Panels

- Ceiling diffuser panels are available in two shapes, convex or pyramidal
- Manufacturer's standard construction of thermo molded plastic, 0.125" (3 mm) material thickness with white, "lemon-peel" finish. NOT fabric covered
- Surface is paintable using latex acrylic paint only Recyclable
- Constructed of Class A material according to NFPA 101 Life Safety Code Requirements
- Lay-In ceiling panels attach securely to a suspended ceiling grid (safety cables provided)
- For a suspended ceiling grid, please specify if using standard or designer grid system
- Clip-In ceiling panels may be direct mounted to permanent ceiling, or suspended from ceiling by wire from four corner hooks
- Five-year warranty

## Pyramidal Ceiling Diffuser Panels

Nominal Dimensions	Actual Dimensions	Weight
<b>Lay-in Panel (for designer or standard grid)</b>		
2' x 2' x 6" (610 x 610 x 152 mm)	23-5/8" x 23-5/8" x 6" (600 x 600 x 152 mm)	6 lb (2.26 kg)
4' x 4' x 16" (1219 x 1219 x 406 mm)	47-5/8" x 47-5/8" x 15.46" (1210 x 1210 x 393 mm)	15 lb (6.80 kg)
<b>Clip-in Panel (for direct mount or wire suspended) 4' x 4' (1219 x 1219 mm) Panels only</b>		
4' x 4' x 15" (1219 x 1219 x 381 mm)	46-3/4" x 46-3/4" x 15" (1187 x 1187 x 381 mm)	15 lb (6.80 kg)

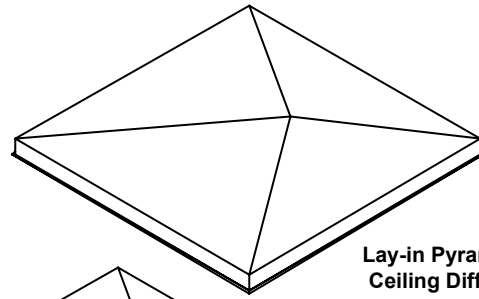

Lay-in Pyramidal Ceiling Diffuser

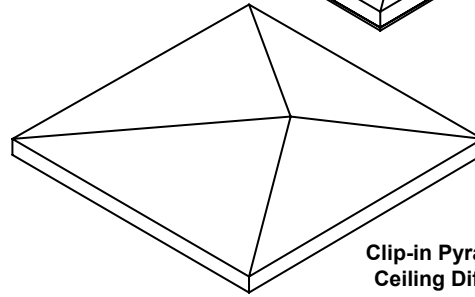

Clip-in Pyramidal Ceiling Diffuser

## Acoustical Performance - 4' (1219 mm) Panels only

Sound Absorption Coefficient							
One-Third Octave Band Center Frequency (Hz)							
Mounting Type		125	250	500	1000	2000	4000
<b>Ceiling Diffusers 4' x 4' (1219 x 1219 mm) Convex</b>							
A		0.20	0.11	0.07	0.04	0.09	0.21
E-400		0.21	0.16	0.16	0.15	0.14	0.26
<b>Ceiling Diffusers 4' x 4' (1219 x 1219 mm) Pyramidal</b>							
A		0.27	0.18	0.09	0.06	0.03	0.00
E-400		0.21	0.14	0.13	0.13	0.18	0.27
<b>Type I Wall Diffusers 4' x 4' (1219 x 1219 mm) Convex</b>							
A		0.18	0.18	0.13	0.10	0.12	0.16
F-7		0.25	0.14	0.11	0.10	.13	0.16
<b>Type I Wall Diffusers 4' x 4' (1219 x 1219 mm) Pyramidal</b>							
A		0.23	0.18	0.13	0.12	0.14	0.11
F-7		0.22	0.18	0.12	0.12	0.17	0.20
<b>Type II Wall Diffusers 4' x 8' (1219 x 2438 mm)</b>							
A		0.34	0.27	0.14	0.11	0.11	0.19
F-7		0.28	0.29	0.19	0.13	0.13	0.20
A Mounting — 0" (0 mm) air space E-400 Mounting — 16" (406 mm) air space F-7 Mounting — 9/32" (7 mm) air space							
Sound Transmission Class (STC), determined according to ASTM E90 and ASTM E413; Type I convex ceiling diffuser panel, 4' x 4' (1219 x 1219 mm); STC 23, Type 1 pyramidal diffuser panel, 4' x 4' (1219 x 1219 mm), STC 22							

# Installation

Acoustical Wall Panels are designed for easy installation  
 Panels are shipped fully assembled with mounting brackets included for a secure installation  
 Brackets are fastened (fasteners not included) to virtually any wall surface (Fig. 1)  
 and the panels mount easily onto the wall brackets (Fig. 2)

## Wall Diffuser Installation

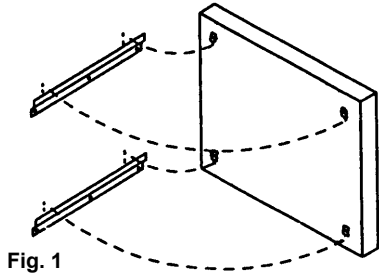

Fig. 1

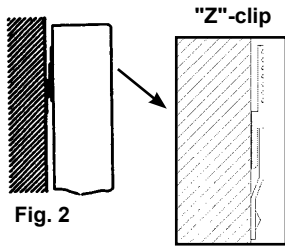
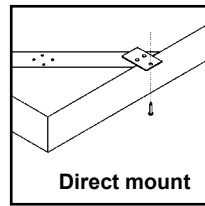
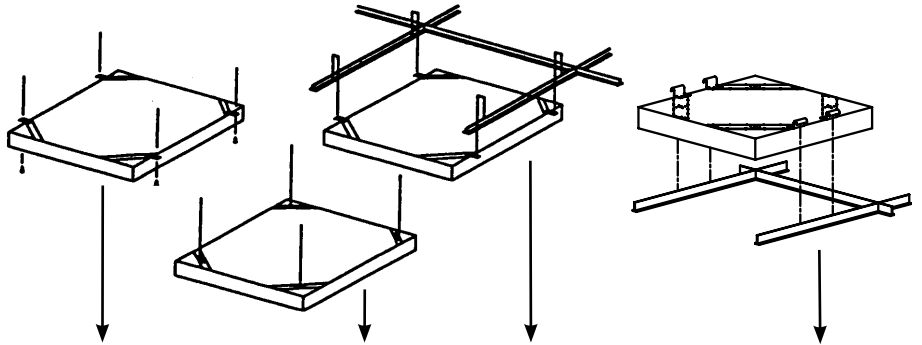
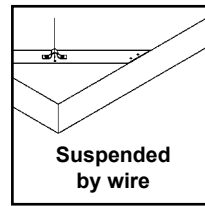

Fig. 2

## Ceiling Diffuser Installation



Direct mount



Suspended by wire

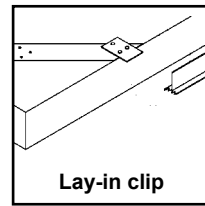

Lay-in clip

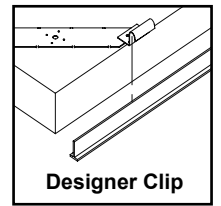

Designer Clip

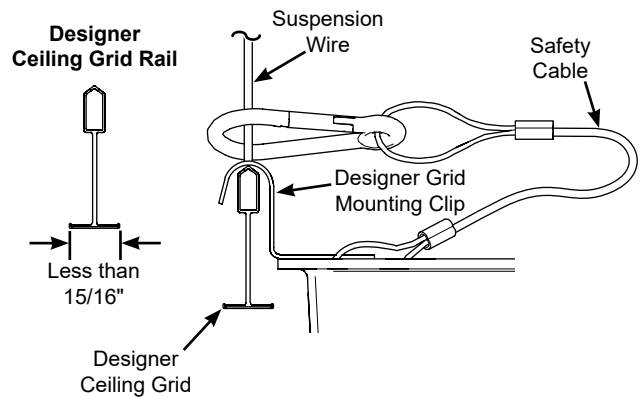
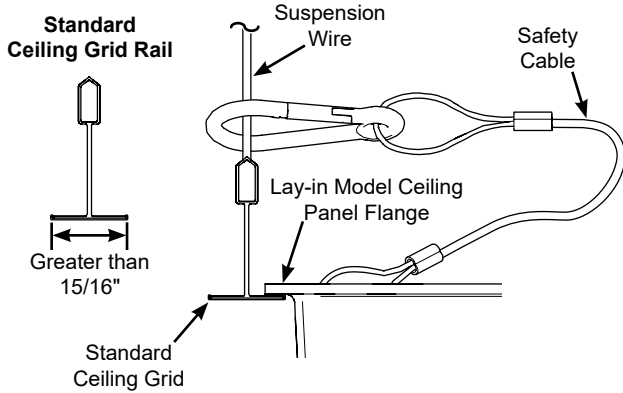

© 2019 Wenger Corporation  
 USA/2019-06/W



WENGER CORPORATION

Phone 800.4WENGER (493-6437) Worldwide +1.507.455.4100 | Parts & Service 800.887.7145 | Canada Office 800.268.0148 | wengercorp.com  
 555 Park Drive, PO Box 448 | Owatonna MN 55060-0448

JR CLANCY

Phone 800.836.1885 Worldwide +1.315.451.3440 | jrclancy.com | 7041 Interstate Island Road | Syracuse NY 13209-9713

GEARBOSS

Phone 800.493.6437 | email gearboss@wengercorp.com | gearboss.com | 555 Park Drive, PO Box 448 | Owatonna MN 55060-0448