

Traditional Acoustic Panel Series: Diffuser Panels



Diffuser Panels

Diffuser panels include convex and pyramidal shaped ceiling and wall panels.

Only wall panels are fabric covered utilizing the Guilford of Maine Company's FR701® Style 2100 series of fabric in a variety of colors.

- Corners are reinforced with diagonal supports, which also provide a secure anchor for the mounting hardware
- Final assembly meets 2018 IBC requirements for Class A interior finishes
- Five-year warranty

Wall Diffuser Panels, Type I (Convex)

- Constructed thermo molded plastic, 0.125" (3 mm) material thickness
- Recyclable

Nominal Dimensions	Actual Dimensions	Weight
2' x 2' x 5" (610 x 610 x 127 mm)	22-3/4" x 22-3/4" x 4-3/4" (578 x 578 x 121 mm)	6 lb (2.72 kg)
3' x 3' x 6" (914 x 914 x 152 mm)	35-1/4" x 35-1/4" x 5-3/4" (895 x 895 x 146 mm)	13.5 lb (6.12 kg)
3' x 4' x 6" (914 x 1219 x 152 mm)	35-1/4" x 47" x 5-3/4" (895 x 1194 x 146 mm)	18 lb (8.16 kg)
3' x 6' x 6" (914 x 1829 x 152 mm)	35-1/4" x 71" x 5-3/4" (895 x 1803 x 146 mm)	27 lb (12.25 kg)
4' x 2' x 5" (1219 x 610 x 127 mm)	47" x 23-1/2" x 4-7/8" (1193 x 60 x 124 mm)	12 lb (5.44 kg)
4' x 3' x 6" (1219 x 914 x 152 mm)	47" x 35-1/4" x 5-3/4" (1193 x 895 x 146 mm)	18 lb (8.16 kg)
4' x 4' x 7" (1219 x 1219 x 178 mm)	47" x 47" x 6.81" (1193 x 1193 x 173 mm)	24 lb (10.89 kg)
4' x 6' x 8" (1219 x 1829 x 203 mm)	47" x 71" x 7-3/8" (1193 x 1803 x 187 mm)	36 lb (16.33 kg)
4' x 8' x 8" (1219 x 2438 x 203 mm)	47" x 95" x 7-3/8" (1193 x 2413 x 187 mm)	48 lb (21.77 kg)

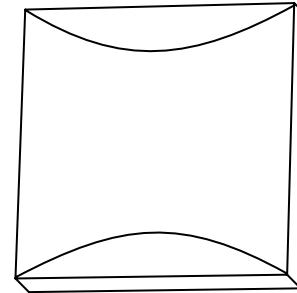

Type I Wall Diffuser Panel

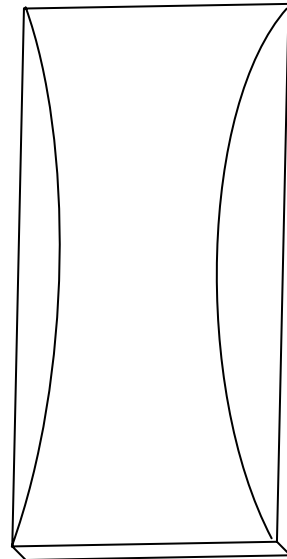

Type II Wall Diffuser Panel

Wall Diffuser Panels, Type II (Convex)

- Constructed of thermo molded plastic, 0.125" (3 mm) material thickness with glass fiber board glued to rear surface of panel
- Recyclable

Nominal Dimensions	Actual Dimensions	Weight
3' x 6' x 6" (914 x 1829 x 152 mm)	35-1/4" x 71" x 5-3/4" (895 x 1803 x 146 mm)	36 lb (16.33 kg)
4' x 6' x 8" (1219 x 1829 x 203 mm)	47" x 71" x 7-3/8" (1194 x 1803 x 187 mm)	48 lb (21.77 kg)
4' x 8' x 8" (1219 x 2438 x 203 mm)	47" x 95" x 7-3/8" (1194 x 2413 x 187 mm)	64 lb (29.03 kg)

Pyramidal Wall Diffuser Panels

Nominal Dimensions	Actual Dimensions	Weight
4' x 4' x 15" (1219 x 1219 x 381 mm)	46-3/4" x 46-3/4" x 15" (1187 x 1187 x 381 mm)	15 lb (6.80 kg)

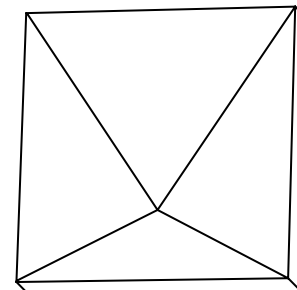

Pyramidal Wall Diffuser Panel

Ceiling Diffuser Panels

- Ceiling diffuser panels are available in convex or pyramidal shapes
- Manufacturer's standard construction of thermo molded plastic 0.125" (3 mm) material thickness with white "lemon-peel" finish, NOT fabric covered
- Surface is paint-able using latex acrylic paint only
- Final assembly meets 2018 IBC requirements for Class A interior finishes
- Lay-In ceiling panels attach securely to a suspended ceiling grid (safety cables provided)
- For a suspended ceiling grid, please specify if using standard or designer grid system
- Clip-In ceiling panels may be direct mounted to permanent ceiling, or suspended from ceiling by wire from four corner hooks
- Recyclable
- Five-year warranty

Convex Ceiling Diffuser Panels

Nominal Dimensions	Actual Dimensions	Weight
Lay-in Panel (for designer or standard grid)		
2' x 2' x 6" (610 x 610 x 152 mm)	23-5/8" x 23-5/8" x 5-1/4" (600 x 600 x 133 mm)	3 lb (1.36 kg)
4' x 2' x 6" (1219 x 610 x 152 mm)	47-5/8" x 23-5/8" x 5-1/4" (1210 x 600 x 133 mm)	8 lb (3.63 kg)
4' x 4' x 8" (1219 x 1219 x 203 mm)	47-5/8" x 47-5/8" x 7-1/4" (1210 x 1210 x 184 mm)	15 lb (6.80 kg)
Clip-in Panel (for direct mount or wire suspended)		
2' x 2' x 5" (610 x 610 x 127 mm)	22-5/8" x 22-5/8" x 4-3/4" (575 x 575 x 121 mm)	3 lb (1.36 kg)
4' x 2' x 5" (1219 x 610 x 127 mm)	46-7/8" x 23-1/8" x 4-3/4" (1191 x 587 x 121 mm)	8 lb (3.63 kg)
4' x 4' x 7" (1219 x 1219 x 178 mm)	46-3/4" x 46-3/4" x 6.81" (1187 x 1187 x 173 mm)	15 lb (6.80 kg)

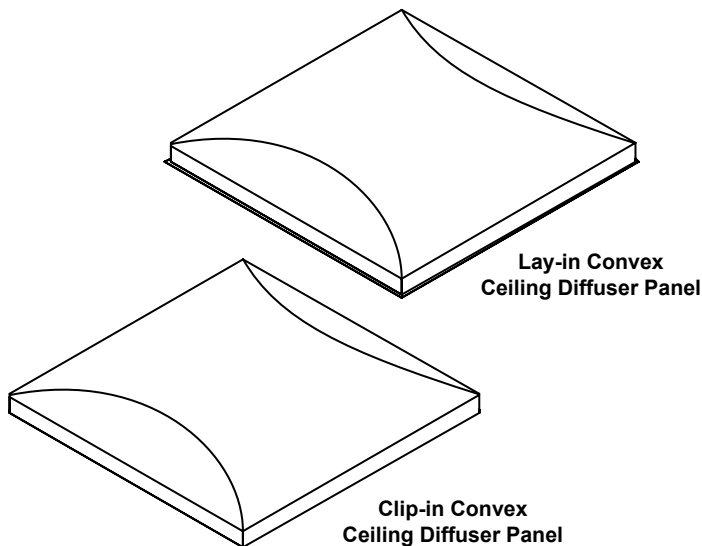

Pyramidal Ceiling Diffuser Panels

Nominal Dimensions	Actual Dimensions	Weight
Lay-in Panel (for designer or standard grid)		
2' x 2' x 6" (610 x 610 x 152 mm)	23-5/8" x 23-5/8" x 6" (600 x 600 x 152 mm)	6 lb (2.26 kg)
4' x 4' x 16" (1219 x 1219 x 406 mm)	47-5/8" x 47-5/8" x 15.46" (1210 x 1210 x 393 mm)	15 lb (6.80 kg)
Clip-in Panel (for direct mount or wire suspended)		
4' x 4' (1219 x 1219 mm) Panels only		
4' x 4' x 15" (1219 x 1219 x 381 mm)	46-3/4" x 46-3/4" x 15" (1187 x 1187 x 381 mm)	15 lb (6.80 kg)

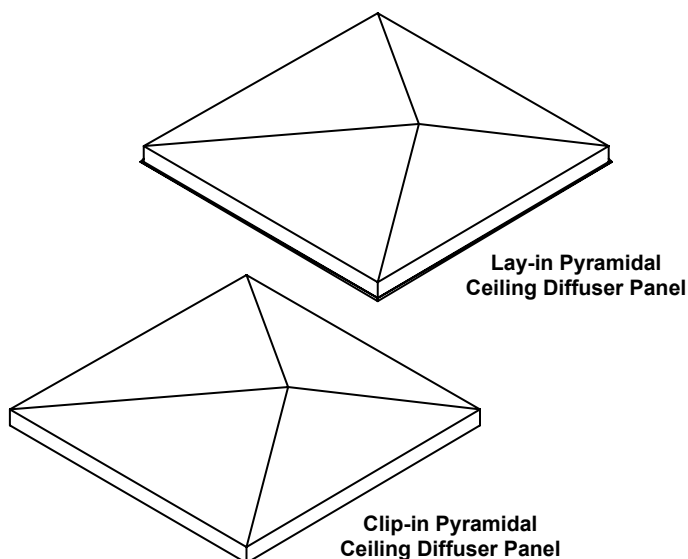

Acoustical Performance - 4' (1219 mm) Panels only

Sound Absorption Coefficient							
One-Third Octave Band Center Frequency (Hz)							
Mounting Type		125	250	500	1000	2000	4000
Ceiling Diffusers 4' x 4' (1219 x 1219 mm) Convex							
A		0.20	0.11	0.07	0.04	0.09	0.21
E-400		0.21	0.16	0.16	0.15	0.14	0.26
Ceiling Diffusers 4' x 4' (1219 x 1219 mm) Pyramidal							
A		0.27	0.18	0.09	0.06	0.03	0.00
E-400		0.21	0.14	0.13	0.13	0.18	0.27
Type I Wall Diffusers 4' x 4' (1219 x 1219 mm) Convex							
A		0.18	0.18	0.13	0.10	0.12	0.16
F-7		0.25	0.14	0.11	0.10	.13	0.16
Type I Wall Diffusers 4' x 4' (1219 x 1219 mm) Pyramidal							
A		0.23	0.18	0.13	0.12	0.14	0.11
F-7		0.22	0.18	0.12	0.12	0.17	0.20
Type II Wall Diffusers 4' x 8' (1219 x 2438 mm)							
A		0.34	0.27	0.14	0.11	0.11	0.19
F-7		0.28	0.29	0.19	0.13	0.13	0.20
A Mounting — 0" (0 mm) air space E-400 Mounting — 16" (406 mm) air space F-7 Mounting — 9/32" (7 mm) air space Sound Transmission Class (STC), determined according to ASTM E90 and ASTM E413; Type I convex ceiling diffuser panel, 4' x 4' (1219 x 1219 mm); STC 23, Type 1 pyramidal diffuser panel, 4' x 4' (1219 x 1219 mm), STC 22							

Installation

- Acoustic Panels are designed for easy installation
- Panels are shipped fully assembled with mounting brackets included for a secure installation
- Brackets are fastened (fasteners not included) to the wall surface (Fig. 1) and the panels mount easily onto the brackets (Fig. 2)

Wall Diffuser Installation

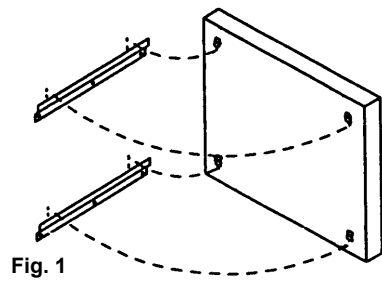

Fig. 1

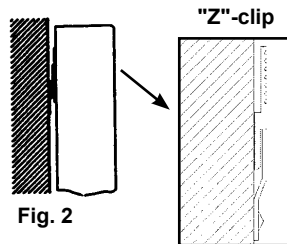
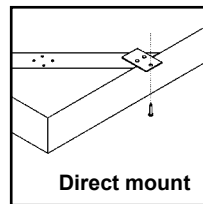
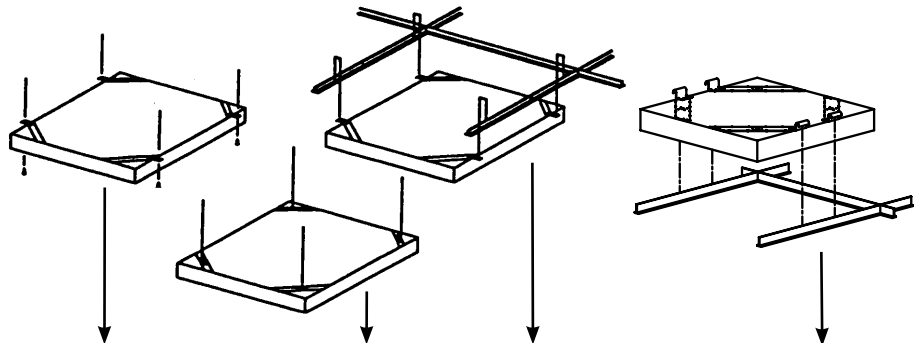
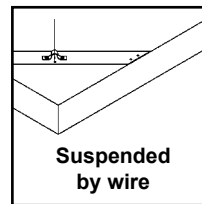

Fig. 2

Ceiling Diffuser Installation



Direct mount



Suspended by wire

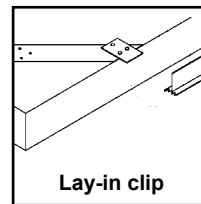

Lay-in clip

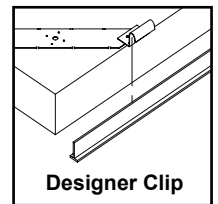

Designer Clip

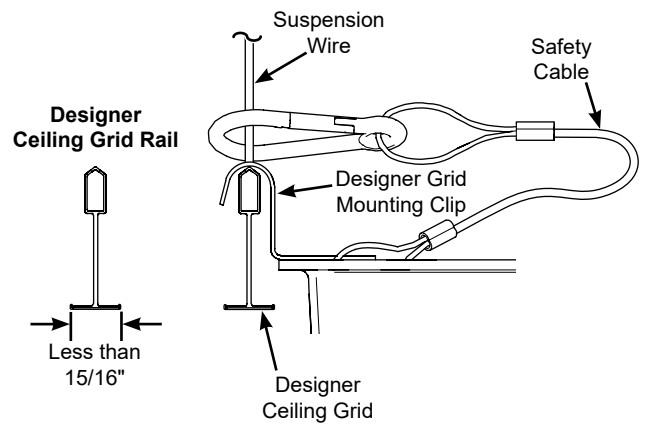
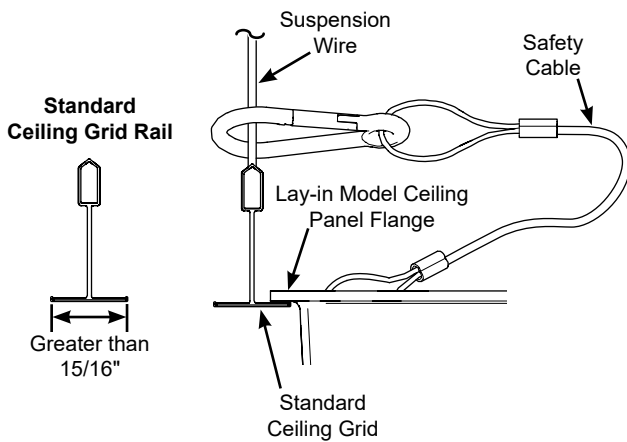

Wenger®

JRCLANCY

GEARBOSS

© 2020 Wenger Corporation
 USA/2020-12

MUSIC EDUCATION AND PERFORMING ARTS

Owatonna Office: Phone 800.4WENGER (493-6437) Worldwide +1.507.455.4100 | Parts & Service 800.887.7145 | wengercorp.com
 555 Park Drive, PO Box 448 | Owatonna | MN 55060-0448

Syracuse Office: Phone 800.836.1885 Worldwide +1.315.451.3440 | jrclancy.com | 7041 Interstate Island Road | Syracuse | NY 13209-9713

ATHLETICS Phone 800.493.6437 | email gearboss@wengercorp.com | gearboss.com | 555 Park Drive, PO Box 448 | Owatonna | MN 55060-0448